

# SINGER<sup>®</sup> WASHING MACHINE

WT5113

## USER *Manual*

WASHING MACHINE

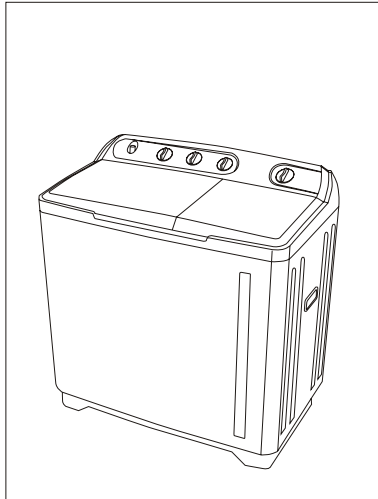

CONTENTS

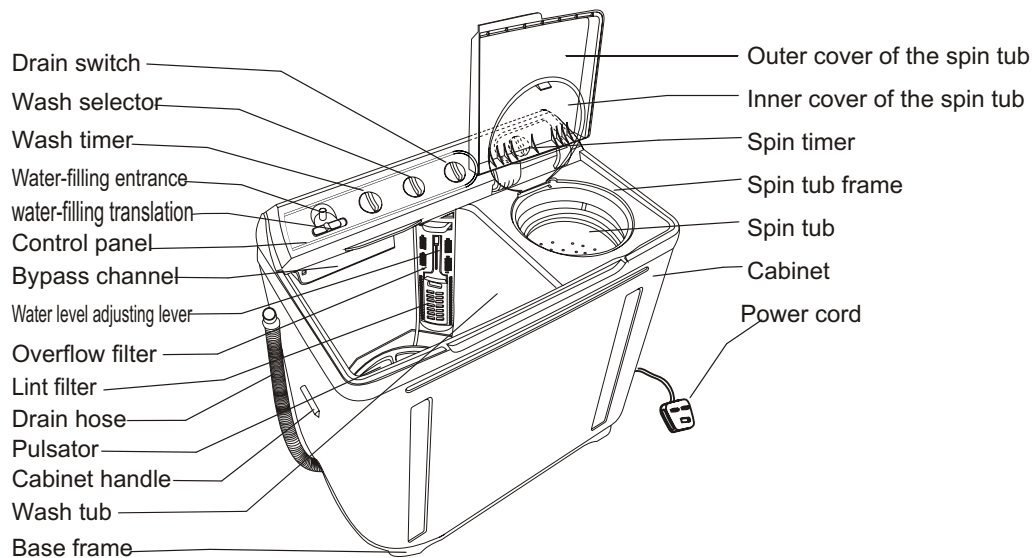

- Names of the parts
- Safety precautions
- Installation and adjustment
- Preparation before washing
- Do's and don'ts
- Usage of the detergent
- Washing sequence
- Maintenance
- Trouble-Shooting \*Answers to question
- Packing list \*Specification

# SINGER® Names of the parts



Notes: All illustrations in this Manual are given for reference only. Your products and accessories may show differences from these illustrations due to our continuous improvement.

## Meaning and description of the symbols

<p>Warning sign</p> 	<p>Contents marked with that symbol are related to the safety of the product and the personal safety of the users. Please operate in strict conformity to the contents, otherwise it may cause damage of the machine or injure the personal safety of the user.</p>
<p>Forbidding sign</p> 	<p>Contents marked with that symbol are actions forbidden to perform. Performing of those actions may result in damage of the machine or injure the personal safety of he user.</p>

- Please check if the power receptacle has good earthing condition before using to guarantee your safety.

# SINGER® Safety precautions

Please insert the power cord into special receptacle with rated voltage. Be sure to use single-phase three pins receptacle. The earthing terminal of the receptacle must be earthed reliably. If possible, please adopt electric leakage protector.

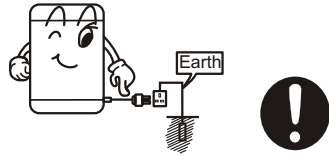

When the machine is normally using, please put the power plug at the location easily to be inserted and extracted by hand. Be sure to pull the plug off when there's power failure, or the machine is being moved, cleaned or when it is idle.

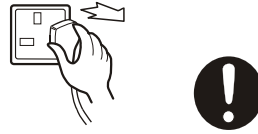

If the power cord is bad, to avoid risk it is required to replace it by the technicians of our special shop or the after-sale service department. Keep the pin of the power plug clean.



Do not put the machine at damp place like the bathroom. Never wash it with water. Do not place wet laundries on the control panel.

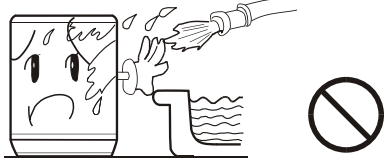

Do not use water hotter than 65°C.

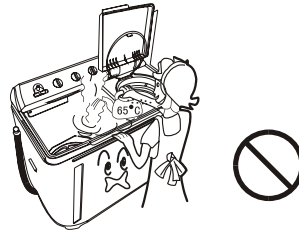

In case the washing machine is installed on ground with carpet, do not block the ventilation hole with carpet.

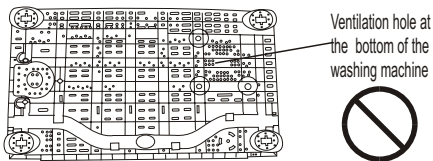

Do not wash water-proof laundries like the raincoat, bike covers etc. to avoid abnormal vibrations in spinning.



Do not let the machine share one receptacle with other electric appliances. If the power plug is damaged, or the plugging into the receptacle is loose, do not use the plug any more.

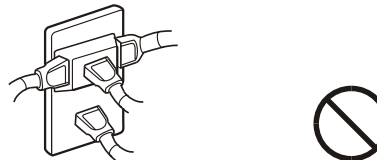

# SINGER® Safety precautions

Do not stretch hands into the working machine. It is dangerous even if the rotation is slow. Take special care of the children.



Do not decompose, repair or alter the machine by yourself.

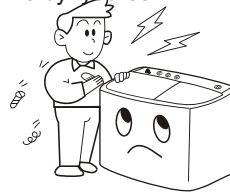

Do not put any hot or heavy items (such as the kettle with hot water) on the washing machine.



Do not wash laundries with volatile materials (such as thinner, petrol etc.).

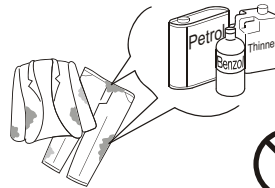

Handicapped or children without care shall not use the machine.

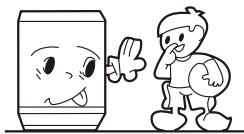

Keep the machine away from direct sunlight and heat source like the heater.



- To protect your laundries and washing machine, please take out all of the coins, buttons, sand, hairpin and other foreign materials before washing.



- Please check if the water faucet is open, and if the connection of the water inlet pipe is proper.
- It is suggested to use foamless washing powder.

# SINGER Installation and adjustment

Please install and adjust the machine according to the requirement of the manual. It is very important to your security and correct operating the machine.

## Install the lint filter

Put the underside of the lint filter into overflow filter then push the upside into overflow filter

- After installation, please refer that the lint filter installed to the right station, otherwise the lint filter may be falled off when washing, influencing your use.

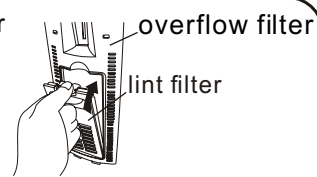

## Usage of the drain hose

The drainage shall be smooth with the drain hose.

1. The height of the drain hose shall be less than 10cm, or the drainage will not be smooth enough and cause incomplete drainage.

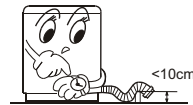

2. Do not tramp or press the drain hose.



3. If the drain hose is too long, cut it at mid point. To make smooth drainage, cut the front end of the hose slantingly.



4. If extra drain hose is needed, please make separate purchase. The inner diameter of the extra hose shall not less than 40mm, and the length shall not exceed 1.5m.

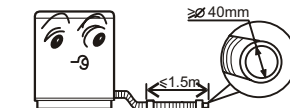

If the extra hose is too long, cut it either at point A or B.

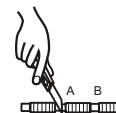

# SINGER®

## How to change the direction of the drain hoses

- Figure 1 indicates the ex factory installation position of the drain hose.

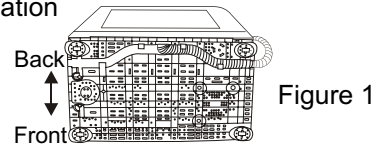

Extend the drain hose from the side of spin tub

- Put soft items on the ground. Lean the machine down gently with the front surface facing the ground. Take off the drain hose from the cabinet. Take the hose out of the fixing groove. (See to Figure 2).

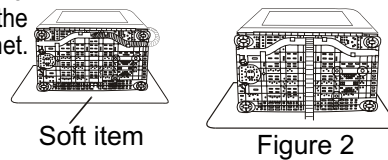

- Embed the drain hose into the groove along the side of the spin tub in the order of (1)~(3), heading for the side of the spin tub. (See to Figure 3).

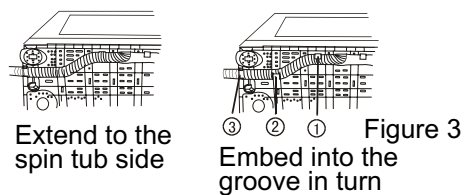

- Embed the drain hose into the groove with hands. Take care not to damage the drain hose in fastening the fixing clamp.

## Install the water inlet hose; Select the water level

- Insert the water inlet hose into the water-filling entrance on the control panel  
(To dismantle the water inlet pipe, just push the control handle as indicated in the figure and pull it out)

- Select water level according to the quantity of the laundries.  
Set the water level adjusting lever to needed line.

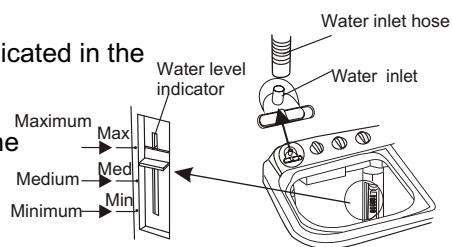

Attention: The appliance is to be connected to the water mains using new hose-sets and that old hose-sets should not be reused.

# SINGER® Preparation before washing



Preparation before washing

1. Connect the water inlet hose.
2. Confirm that the washing machine is earthed reliably. Then insert the power plug into the receptacle. Do not connect the earth terminal to the gas pipe and tap water pipe.
3. Put down the drain hose.

4. Slanting or uneven ground may result in unstable working or abnormal noise. Please make the machine stand horizontally.

Pay attention to followings before washing the laundries

<p>Check if the laundries has special requirement on washing</p>	<p>Clear the pocket. Take out the coins, sand, hairpins etc.</p>	<p>Tie the long strips; fasten the buttons; close zippers.</p>	<p>The quantity of the laundries shall not be too large. Stretch and loosen the laundries before putting them in the tub.</p>	<p>When the pulsator is running, the buttons of the laundries may cause noise. For the sake of discretion, please put the laundries with buttons into other laundries.</p>

- a. Check if the laundries are applicable for washing with machine.
- b. Divide the laundries that are not colorfast from other laundries.
- c. Put those laundries difficult to absorb water into water with hand.
- d. For those laundries with heavy soil, please first remove the dirt like mud or dust. For the parts with heavy soil, please apply detergent on them in advance, which can make it easier to remove the soil.
- e. For those laundries that may get lint ball and those with long fur, turn it over before putting in.
- f. Do not put those laundries polluted by chemicals into the washing machine directly.

# SINGER® Do's and Don'ts

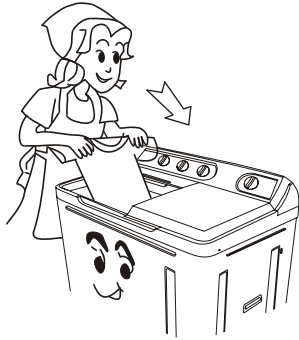

- The capacity of washing and spinning of the machine refer to the largest weight of the standard laundries under dry condition that can be washed or spinned in one time. Laundries quantity in one washing cycle shall be lower than the rated capacity.
- The thickness, size, type of the cloth will influence the actual washing capacity. It is suitable to put in reasonable amount of laundries and the laundries can be turned round in washing for one time washing.
- Do not select "Maximum" water level for few laundries, so as to avoid splashing of water.
- It is suggested not to use high sudsing detergent.

## Usage of the detergent

### How to use the whitener

- Fill water to decided level. Dilute the whitener with container. Pour it slowly into the washing tub
- Avoid using whitener on laundries with color or pattern as they are prone to lose color.
- The whitener shall not touch the laundries directly.
- Refer to the user's manual for the usage and quantity of the whitener.
- For powder whitener, please dissolve it before using.

### How to use the washing powder

- Direct dissolved in the machine:
  1. Fill small quantity of water.
  2. Add the powder. Run for 30 seconds to dissolve it completely.
  3. Put it in the laundries. Select suitable water level.
- The instant dissolving of the washing powder:
  1. Prepare warm water of 30°C and a container.
  2. Add the powder while stirring to fully dissolve it.
- The powder is more prone to pollute the laundries than the detergent. Therefore please use it with proper quantity.
- Dosage of different washing powder is different. Please refer to the instruction of the washing powder for the detail dosage.



# SINGER® Washing sequence

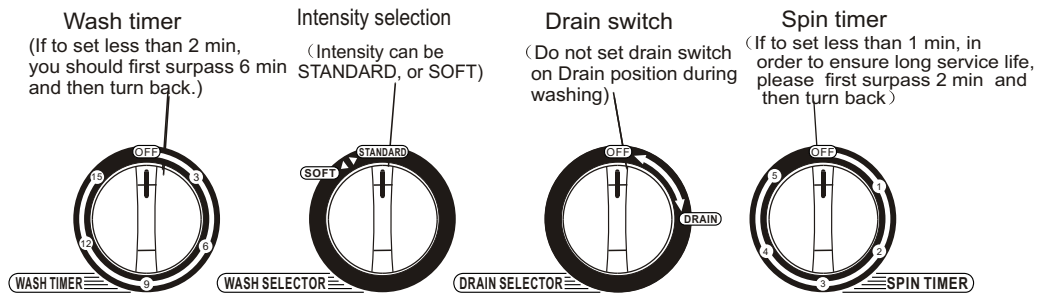

## Wash

### 1、 Inlet selector

- (1) Set inlet selector to “Wash ” side. (Figure 1)
- (2) Adjust water level rod to a position as needed.

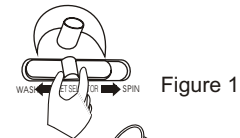

- 2、 Fill water and add solved powder detergent until water reaches a suitable level.  
It begin to wash to dispense detergent uniformly.

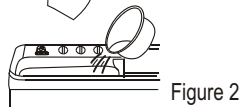

- 3、 Put in the wash load, and supplement water as necessary.

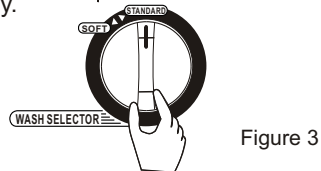

### 4、 Select intensity

- Select soft or standard water flow intensity according to wash load. (Figure 3)

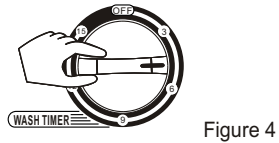

### 5 Select wash time

- Select wash time according to wash load. (Figure 4)

- 6 After completion of wash, please set drain switch at Drain position. (Figure 5)

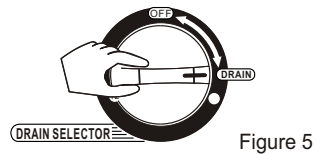

# SINGER®

## Midway spinning

1. Put the laundries into the spin tub evenly and smoothly.

2. Spin: (1) Put the gland in properly.
- Please put in the gland properly even if the laundries quantity is small.

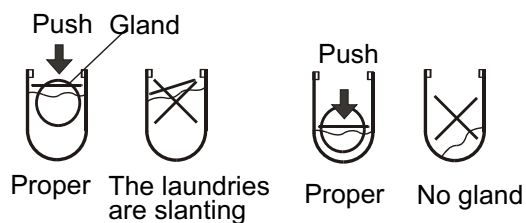

- (2) Close the inner and outer cover of the spin tub.

- (3) Spin for 1-2 minutes.

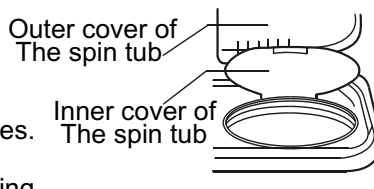

3. Run the foam-removing spinning.

- 1 Set the inlet selector handle on spin side and fill water for about 1 min.
  - In case water flows out from wash tub side due to too much inflow, please turn down the water tap a bit.
- 2 Close the spin tub outer cover and spin for about 1 - 2 min.

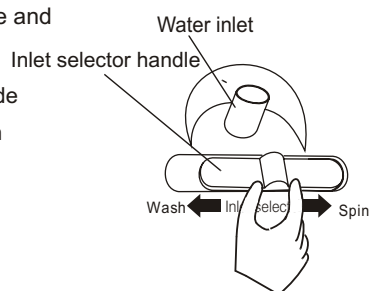

# SINGER®

## Rinsing

### Rinse with water-filing

1. Put the laundries into the wash tub. Select suitable current according to the laundries.

2. Adjust the water level  
Set the water level with water level adjusting lever according to the laundries quantity. Then fill suitable water continuously.

3. Rinse  
Adjust the wash timer to 5-7 minutes to do rinsing.

(Repeat the midway spinning and rinsing with stored water for 2-3 times)

### Rinse with stored water

1. Put the laundries into the wash tub. Select suitable current according to the laundries.

2. Fill water to preset water level.

3. Rinse  
Adjust the wash timer to 2-3 minutes to do rinsing.

When the laundries quantity is few, please use "Soft" current. If you use "Standard" current, it may splash.

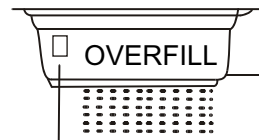

If you find water flowing out here, please twist the water tap to limit the water filling.



# SINGER®

## Spinning

1. Put the laundries into the spin tub evenly and smoothly.
2. Press the gland in the tub properly. Close the inner and outer cover of the spin tub.
3. Spin  
Select suitable spin time according to the laundries, and do spinning.
  - During spinning, if there's abnormal sound, it is generally owing to slanting placement of the laundries. Please stop the machine and re-order the laundries.
  - In spinning, it will pause the work if you open the outer cover of the spin tub. Close it to resume the spinning.



To do spinning and draining or rinsing with water-filling together, please first do spinning for around 1 minute, then do draining or rinsing with water-filling. Otherwise the spinning will stop owing to too much water stored in the spin tub.

# SINGER® Maintenance

- After using, please clean the lint and foreign materials of the lint filter and overflow filter in time. Otherwise it may influence your using the machine.
- Please first pull off the power plug from the receptacle before cleaning.

## Cleaning the lint filter

- The lint filter must be used during washing.
  - It must be cleaned in time after each using.
1. Press the elastic piece at upper end of lint filter to release the tab from the filter cover, and pull the lint filter outward to remove it. (See Figure 1).



Figure 1

2. Remove lint  
Pull the lower end of lint filter rear cover outward to disassemble it from the lint filter front cover. Remove lint completely with clear water. (See Figure 2).

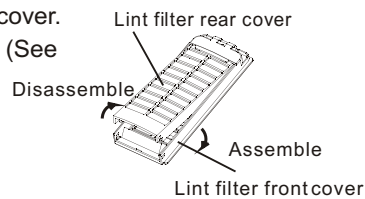

Figure 2

3. Install lint filter



## Cleaning the overflow filter

- Too much lint on the overflow filter will influence the normal usage of the machine. Please clean it every two months.

1. Take off the overflow filter.  
As indicated in the figure, nip the elastic fixing claw and pull it to the direction of the arrow to take it off.

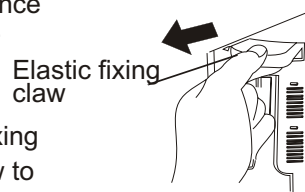

# SINGER®

## Cleaning the overflow filter

2. Take off the corrugation pipe.  
Dismantle the upper part of the corrugation pipe inside the overflow filter ( as indicated in Figure 1).

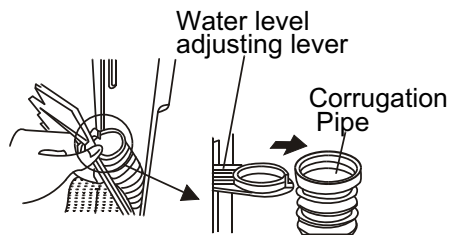

Figure 1

3. Cleaning the overflow filter  
Clean the lint around the filter and flush with tap water.

4. Install the overflow filter.  
(1).Install the corrugation pipe.  
(2).Insert the mounting plate at the bottom of the filter into the valve cover.  
(3).Hang up the hook at the left upper side.  
(4).Push the upper part in as indicated in Figure 2.

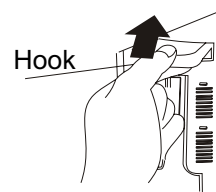

Figure 2

## Disposal of the complete unit

- Wipe the complete unit with soft cloth twisted dry.
- Wipe with neutral detergent if too dirty
- Do not wash it directly by water





- After washing, dismantle the water inlet hose.
- Do not store water in the tub for long period. Discharge the water immediately after each using.
- Pull off the power plug and hang up the power cord.
- Hang up the drain hose.  
Wipe off the water drops on the surface and inside the tub with clean soft cloth.
- Open the cover of the wash tub and the inner/outer cover of the spin tub for some time (about one hour), then close them.

# SINGER® Trouble-shooting Answer to question

(If there's breakdown, please pull off the power plug before checking) The following phenomena are not breakdowns sometimes. Please confirm again before sending it to repair. If there are real breakdowns, please come to the special maintenance department or after-sale service department of our company. Do not repair it by yourself.

Phenomena	The reason
The machine does not function.	<ul style="list-style-type: none"> <li>• Is there power failure?</li> <li>• Is the power plug loose?</li> <li>• Is the pulsator twisted by foreign materials?</li> </ul>
The draining does not function	<ul style="list-style-type: none"> <li>• Has the drain hose being laid down?</li> <li>• Is the drain hose blocked by foreign material?</li> <li>• Are there any laundries trapped at the outer side of the spin tub?</li> </ul>
There's abnormal sound during washing	<ul style="list-style-type: none"> <li>• Are there hair pin, coins or metal items brought inside the tub?</li> </ul>
There's abnormal sound and violent vibration during spinning	<ul style="list-style-type: none"> <li>• Is the machine slanting?</li> <li>• Is the gland pressed evenly?</li> <li>• Are there any laundries trapped at the outer side of the spin tub?</li> <li>• Are the laundries in spin tub over loaded?</li> </ul>

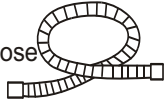
# SINGER® Packing list

Name	Quantity
● User's manual	● One piece
● Water inlet hose 	● One piece
● Warranty card	● One piece
● Gland 	● One piece
● Twin-tub washing machine	● One set

## Specification

Water level / Water quantity (estimated) (L)	Maximum/99 Medium/79 Minimum/59
Rated voltage/Rated Frequency	220V-240V/50Hz
Rated input power for washing	400
Rated input power for spinning	180
Standard rated washing capacity(kg)	12.0
Largest rated washing capacity(kg)	13.0
Standard rated spinning capacity(kg)	7.0
Injection pressure(MPa)	0.02~0.2

\* Specifications may be subject to change without prior notice



SINGER( MALAYSIA) SDN. BHD . (Company No 97871-K)  
Bangunan SINGER ,Lot 6 ,Jalan 51/217 ,Section 51,  
46050 Petaling Jaya,  
Selangor Darul Ehsan,  
Malaysia.



SINGER PARTS & SERVICE CENTRE  
3rd floor,34&36,Jalan Tago 9,  
Taman Perindustrian Tago BT,11  
Sri.Damansara,52200  
Kuala Lumpur  
Malaysia

---

**SINGER**<sup>®</sup>  
AT HOME WORLDWIDE™

# SINGER® Isi kandungan

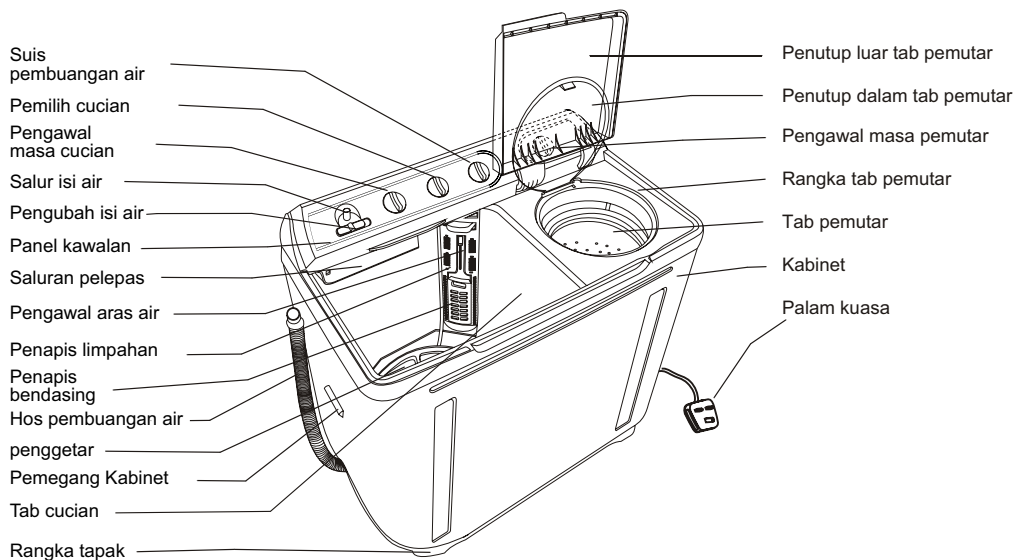

- Nama komponen..... 1
- Langkah keselamatan.....2
- Pemasangan dan penyelarasan.....4
- Penyediaan sebelum mencuci.....6
- Langkah penting mencuci..... 7
- Penggunaan bahan pencuci .....7
- Urutan mencucit..... 8
- Pembuangan lepas mencuci..... 12
- Panduan baikpulih\*Soaljawab..... 14
- Senarai komponen\*Spesifikasi.....15

# SINGER® Nama komponen



Perhatian: Ilustrasi dalam panduan ini untuk rujukan sahaja. Produk dan aksesori anda mungkin berbeza disebabkan pembaharuan semasa.

## Maksud dan penerangan simbol

<p>Tanda amaran</p> 	<p>Berkeaan dengan keselamatan produk dan pengguna. Sila kendali mengikut arahan untuk mengelakkan kerosakan atau kecederaan.</p>
<p>Tanda larangan</p> 	<p>Berkeaan dengan tindakan yang dilarang. Sila patuhi untuk mengelakkan kerosakan atau kecederaan.</p>

- Sila pastikan pbumian soket berfungsi dengan baik untuk keselamatan anda.

# SINGER® Langkah keselamatan

Masukkan palam kuasa ke dalam soket khas dengan voltan bertanda. Sila guna soket tiga pin fasa tunggal. Punca bumi soket mesti dibumikan dengan sempurna. Jika perlu, guna pelindung bocor elektrik.

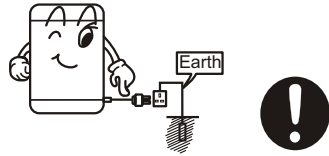

Jika mesin digunakan seperti biasa, letak palam kuasa di tempat yang mudah dicapai tangan. Cabut palam jika bekalan elektrik putus, atau mesin dialih, dibersihkan atau tidak digunakan.



Jika palam kuasa disyaki rosak, sila hubungi juruteknik kedai SINGER atau pusat servis yang terdekat. Pastikan pin palam kuasa bersih.



Jangan letak mesin di tempat basah seperti bilik air. Jangan basuh dengan air. Jangan letak cucian basah di atas panel kawalan.

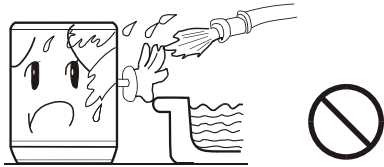

Jangan guna air panas dari 65°C.

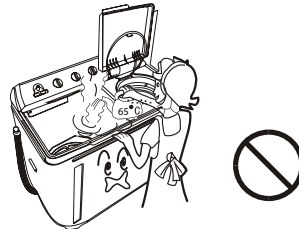

Jika mesin dipasang pada lantai berpermaidani, pastikan lubang edaran udara tidak tertutup dengan permaidani.

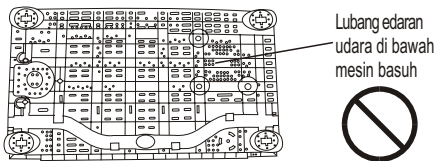

Jangan masukkan cucian kalis air seperti baju hujan, penutup basikal dll untuk elak getaran luar biasa semasa mesin memusing.



Jangan kongsi soket mesin dengan alatan elektrik lain. Jika palam kuasa rosak, atau sambungan soket longgar, jangan guna palam itu lagi.

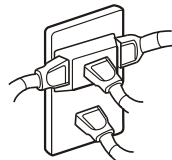

# SINGER® Langkah keselamatan

Jangan masukkan tangan apabila mesin berfungsi. Ini merbahaya walaupun mesin berputar perlahan. Awas dengan kanak-kanak.



Jangan tanggalkan, membaiki atau mengubahsuai mesin ini dengan sendiri.

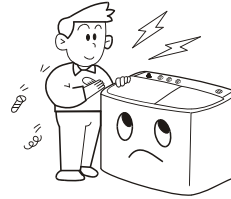

Jangan letak barang panas atau berat (seperti cerek panas) pada mesin.



Jangan masukkan cucian dengan bahan mudah sejat (seperti thinner, petrol dll).

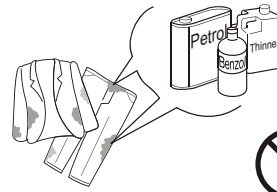

Orang kurang upaya dan kanak-kanak tidak harus menggunakan mesin ini tanpa pengawasan.

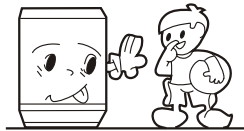

Jauhkan mesin dari pancaran terus cahaya matahari dan punca haba (seperti mesin pemanas).



- Untuk pelihara cucian dan mesin, keluarkan semua syiling, butang, pasir, pin rambut dan objek asing lain sebelum mencuci.



- Pastikan air pili dibuka, dan masukan air paip disambung sempurna.
- Disyor guna serbuk cuci tanpa buih.

# SINGER® Pemasangan dan penyelarasan

Pasang dan selaraskan mesin mengikut buku panduan. Ini penting untuk keselamatan dan memastikan mesin berfungsi dengan sempurna.

## Memasang penapis bendasing

Masukkan bahagian bawah penapis bendasing ke dalam penapis limpahan. Kemudian tekan bahagian atas ke dalam penapis limpahan.

- Selepas memasang, pastikan penapis bendasing ditempatkan dengan betul. Ini untuk mengelaknya terkeluar semasa mencuci dan menjejaskan penggunaan.

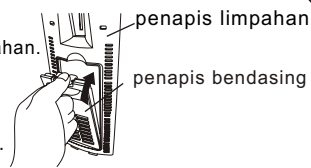

## Penggunaan hos pembuangan air

Hos pembuangan air memudahkan air disalurkan keluar.

1. Tinggi hos pembuangan air harus kurang dari 10cm. Jika tidak, pengaliran air akan terjejas.

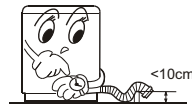

2. Jangan pijak atau tekan hos pembuangan air.



3. Jika hos pembuangan air terlalu panjang, potong mengikut keperluan. Untuk memastikan pengaliran air dengan sempurna, potong condong di bahagian hujung.



4. Jika hos pembuangan air tambahan diperlukan, ia boleh dibeli berasingan. Diameter dalaman hos tambahan tidak harus kurang daripada 40mm. Panjangnya tidak harus melebihi 1.5m.

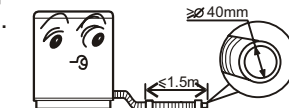

Jika hos tambahan terlalu panjang, potong di titik A atau B.

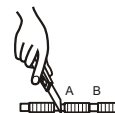

## SINGER® Mengubah arah hos pembuangan air

- Gambarajah 1 menunjukkan kedudukan asal hos dari pemasangan kilang.

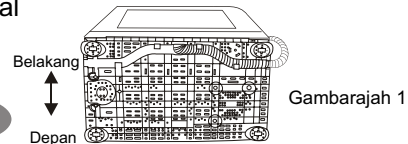

Panjangkan hos pembuangan air dari tepi tab putaran

- Alas lantai dengan objek lembut. Sandar mesin turun secara perlahan, dengan permukaan depan menghadap lantai. Cabut saluran hos dari lekuk pemasangan. (Rujuk Gambarajah 2)

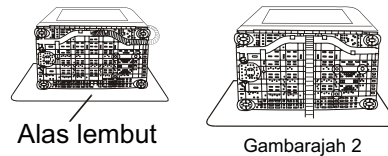

- Letak hos pembuangan air ke dalam lekuk di tepi tab putaran. Ikut urutan (1) - (3), menuju ke tepi tab putaran. (Rujuk Gambarajah 3)

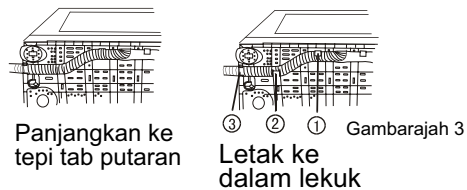

- Letak hos pembuangan air ke dalam lekuk dengan tangan. Pastikan hos tidak dirosak semasa mengetat apit pemasangan.

## Memasang hos masuk air; Memilih paras air

- Masukkan hos masuk air ke dalam salur isi air pada panel kawalan. ( Untuk keluaran paip masuk air, tekan pemegang kawalan seperti ditunjuk pada gambarajah, dan tariknyanya keluar.

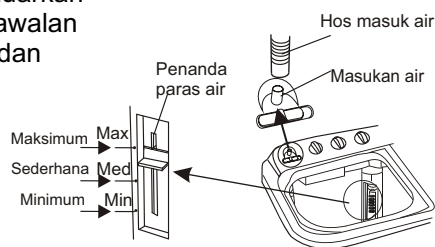

- Pilih paras air mengikut kuantiti cucian. Laras penanda paras air ke tahap dihendaki.

Perhatian:Alatan ini harus disambung ke punca air dengan hos baru.  
Jangan guna semula hos lama.

# SINGER® Penyediaan sebelum mencuci



Penyediaan sebelum mencuci

1. Sambung hos masuk air.
2. Pastikan mesin cuci dibumikan dengan sempurna. Masukkan palam kuasa ke dalam soket. Jangan sambung punca bumi kepada salur gas atau salur air pili.
3. Pasang hos pembuangan air.

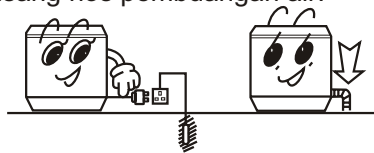

4. Lantai condong atau tidak rata boleh menyebabkan fungsi mesin terjejas atau bunyi luar biasa. Pastikan mesin berdiri tegak.

Perhatikan yang berikut sebelum mencuci

<p>Periksa jika cucian ada keperluan mencuci khas.</p>	<p>Kosongkan poket. Keluarkan syiling, pasir, pin rambut dll.</p>	<p>Ikat jaluran panjang (lengan dll); butangkan; tutupkan zip.</p>	<p>Kuantiti cucian tidak harus berlebihan. Regang dan longgar cucian sebelum masukkan ke dalam tab.</p>	<p>Semasa penggetar berfungsi, butang pada cucian mungkin menyebabkan bunyi luar biasa.</p>
<ol style="list-style-type: none"> <li>a. Pastikan bahan cucian yang sesuai dicucikan dengan mesin.</li> <li>b. Asingkan cucian yang mudah tertanggal warna.</li> <li>c. Masukkan cucian kurang serap air ke dalam air dengan tangan.</li> <li>d. Untuk cucian dikotori tanah, keluarkan dahulu kotoran seperti lumpur atau habuk. Bubuh bahan pencuci pada bahagian amat kotor sebelum mencuci.</li> <li>e. Untuk cucian berbulu panjang yang boleh dapat bebola "lint", terbalikkan bahagian dalam keluar sebelum mencuci.</li> <li>f. Jangan masukkan terus cucian yang tercemar bahan kimia ke dalam mesin basuh.</li> </ol>				



## SINGER® Langkah penting mencuci



- Muatan cucian dan putaran mesin merujuk pada berat maksimum yang boleh dicuci atau diputar sekaligus. (Cucian harus biasa dan kering)  
Kuantiti cucian sekali basuhan harus kurang dari muatan bertanda.
- Ketebalan, saiz, jenis kain akan mempengaruhi muatan cucian sebenar. Pastikan kuantiti cucian tidak terlebih sehingga ia tidak dapat diputar semasa dicuci.
- Jangan pilih paras air "Maximum" jika kuantiti cucian kurang, untuk mengelakkan air dari terpercik.
- Penggunaan bahan pencuci berbau banyak tidak digalakkan.

## Penggunaan bahan pencuci

### Cara mengguna peluntur

- Isikan air ke tahap tertentu. Cairkan peluntur dalam bekas. Tuang perlahan ke dalam tab cucian.
- Jangan guna peluntur pada cucian berwarna atau bercorak, untuk mengelakkan warna dari tertanggal.
- Peluntur tidak harus bersentuh terus dengan cucian.
- Rujuk panduan pengguna untuk penggunaan dan kuantiti atau jumlah peluntur.
- Untuk peluntur serbuk, cairkan dahulu sebelum digunakan.

### Cara mengguna serbuk cuci

- Larut terus dalam mesin:
  1. Isi sedikit air.
  2. Tambah serbuk. Jalankan mesin untuk 30 saat bagi larut sepenuhnya.
  3. Masukkan cucian. Pilih tahap air sesuai.
- Larut terus:
  1. Sedia air suam 30°C dan bekas.
  2. Isi serbuk dan kacau untuk larut sepenuhnya.
- Serbuk cuci mungkin akan mencemarkan cucian, berbanding dengan bahan pencuci. Sila guna kuantiti berpatutan.
- Kuantiti serbuk cuci diperlu mungkin berbeza. Rujuk arahan serbuk cuci untuk butiran.

# SINGER® Urutan mencuci

**Pengawal masa cucian**  
(Jika laras kurang dari 2 minit, laras melebihi 6 minit, kemudian laras balik.)

**Pemilih kekuatan**  
(Kekuatan boleh dilaras "Standard" (biasa), "Soft" (perlahan) atau "Jeans")

**Suis saluran**  
(Jangan laras suis saluran ke "Drain" semasa mencuci)

**Pengawal masa pemutar**  
(Jika laras kurang dari 1 minit, sila laras melebihi 2 minit dahulu, kemudian laras balik. Ini untuk menjamin mesin tahan lama.)

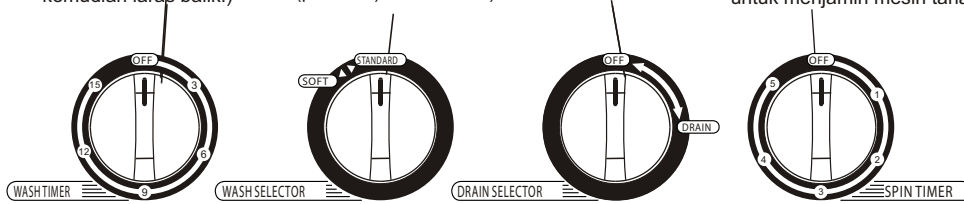

## Cucian

### 1. Pemilih masukan

- (1) Laras pemilih masukan ke "Wash". (Gambarajah 1)
- (2) Laras pengawal paras air seperti dihendaki.

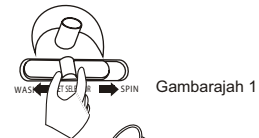

### 2. Isi air dan tambah serbuk cuci cair hingga air sampai tahap sesuai.

Cucian akan bermula, untuk sebar bahan pencuci dengan seragam.

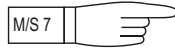

### 3. Masukkan muatan cucian, dan tambah air

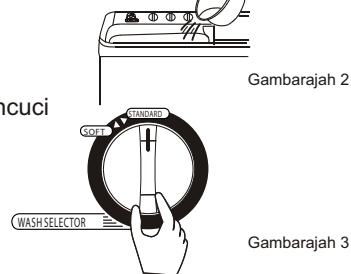

### 4. Pilih aliran air "Soft" (perlahan) atau "Standard". (biasa) Pilih kekuatan mengikut muatan cucian. (Gambarajah 3)

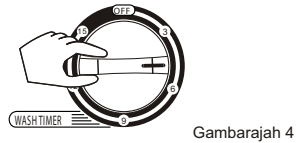

### 5. Pilih masa cucian Pilih masa cucian mengikut muatan cucian. (Gambarajah 4)

### 6. Setelah habis mencuci, laras suis saluran balik ke "Drain". (Gambarajah 5)

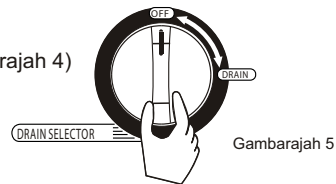

## Putaran setengah masa

1. Masukkan cucian ke dalam tab pemutar dengan cermat dan sekata.

2. Putaran: (1) Masukkan pundi dengan betul.

- Pastikan ia dimasuk betul walaupun kuantiti cucian sedikit.

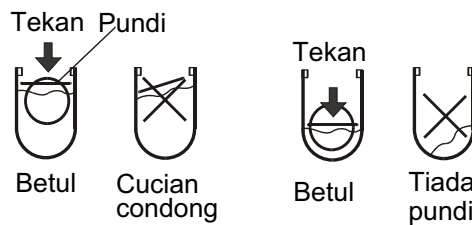

(2) Tutup penutup dalam dan luar tab pemutar.

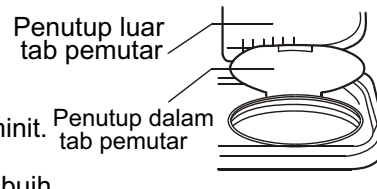

(3) Putar untuk 1-2 minit.

3. Mulakan putaran membuang buih.

1 Laras kawalan pemilih masukan ke "Spin" (putar) dan isi air untuk kira-kira 1 minit.

- Jika air melimpah keluar dari tepi tab cucian, perlahankan aliran air pili.

2 Tutup penutup luar tab pemutar dan biarkan putar untuk kira-kira 1-2 minit.

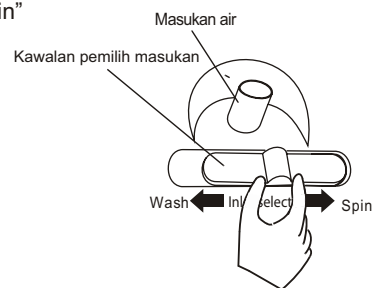

## Membilas

### Bilas dengan air isian

1. Masukkan cucian ke dalam tab cucian.  
Pilih aliran sesuai mengikut jenis cucian.

2. Melaras paras air.  
Guna pengawal paras air untuk laras paras air, mengikut kuantiti cucian.  
Kemudian isi air sesuai berterusan.

3. Bilas  
Laras pengawal masa cucian ke 5-7 minit untuk membilas.  
(Ulang putaran setengah masa dan membilas dengan air simpanan untuk 2-3 kali)

### Bilas dengan air simpanan

1. Masukkan cucian ke dalam tab cucian.  
Pilih aliran sesuai mengikut jenis cucian.

2. Isikan air ke paras yang diselaraskan.

3. Bilas  
Laras pengawal masa cucian ke 2-3 minit untuk membilas.

Jika kuantiti cucian sedikit, guna aliran "Soft" (perlahan).  
Jika anda guna aliran "Standard" (biasa), air mungkin terpercik.

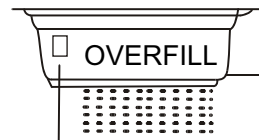

Jika air keluar di sini,  
perlahankan pili air  
untuk mengurangkan  
isian air.



## Memutar

1. Masukkan cucian ke dalam tab pemutar dengan cermat dan sekata.
2. Tekan pundi ke dalam tab dengan baik. Tutup penutup dalam dan luar tab pemutar.
3. Memutar/ Mengering  
Pilih masa putaran yang sesuai mengikut cucian, dan mula putar.
  - Jika bunyi luar biasa muncul semasa memutar, ia biasa disebabkan cucian diletak condong. Hentikan mesin dan atur semula cucian.
  - Jika anda buka penutup luar tab pemutar semasa putaran, proses akan terhenti. Tutup semula untuk menyambung putaran.



Untuk putar dan salur atau bilas dengan isi air, sila putar untuk kira-kira 1 minit. Lepas itu, mula salur atau bilas dengan isi air. Jika tidak, putaran akan terhenti kerana terlalu air dalam tab pemutar.

# SINGER® Pembuangan lepas mencuci

- Lepas guna, bersihkan bendasing dalam penapis bendasing dan penapis limpah segera. Jika tidak, fungsi mesin boleh terjejas.
- Sila cabut palam kuasa dari soket sebelum membersihkan.

## Membersih penapis bendasing

- Penapis bendasing mesti diguna semasa cucian.
- Ia mesti dibersih segera setiap kali lepas diguna.

1. Tekan getah di bahagian atas penapis bendasing untuk buka kancing penutup penapis. Tarik penapis keluar untuk keluarkan. (Rujuk Gambarajah 1).



Gambarajah 1

2. Keluarkan bendasing

Tarik bahagian bawah penutup belakang penapis bendasing untuk memisahkannya dari penutup depan penapis bendasing. Cuci dengan air untuk menghilangkan bendasing atau kotoran. (Rujuk Gambarajah 2)

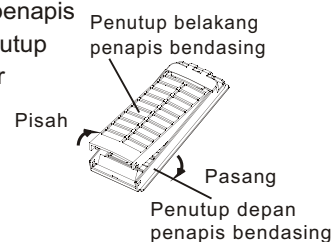

Gambarajah 2

3. Pasang penapis bendasing



## Membersih penapis limpahan

- Jika terlalu bendasing di penapis limpahan, fungsi biasa mesin akan terjejas. Sila bersihnya setiap dua bulan.

1. Keluarkan penapis limpahan.

Seperti ditunjuk, sepih cangkuk pemasangan getah, dan tarik ikut arah anak panah untuk keluarkannya.

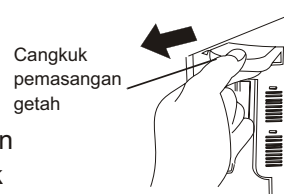

# SINGER®

## Membersih penapis limpahan

2. Keluarkan paip beralur.  
Pisah bahagian atas paip beralur dalam penapis limpahan. (Rujuk Gambarajah 1)

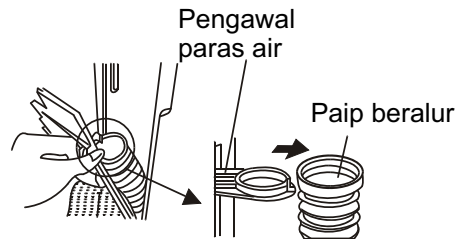

Gambarajah 1

3. Membersih penapis limpahan.  
Bersihkan bendasing di sekitar penapis dan simbah dengan air pili.

4. Memasang penapis limpahan.  
(1).Pasang paip beralur.  
(2).Masukkan piring bingkai di bawah penapis ke dalam penutup injap.  
(3).Gantung cangkuk pada bahagian kiri atas.  
(4).Tekan masuk bahagian atas. (Rujuk Gambarajah 2)

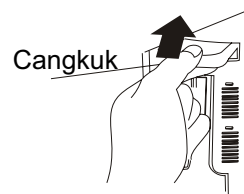

Gambarajah 2

## Langkah-langkah penjagaan mesin basuh

- Lap seluruh mesin dengan kain lembut dipulas kering.
- Jika terlalu kotor, lap dengan bahan pencuci semulajadi.
- Jangan cuci terus dengan air.



- Lepas cuci, cabut keluar hos masukan air.
- Jangan simpan air di dalam tab untuk jangka masa yang lama. Buangkan segera setiap kali selepas digunakan.
- Cabut palam kuasa dan gantung wayar kuasa.
- Gantung hos pembuangan air. Lap titisan air pada permukaan dan dalam tab dengan kain bersih lembut.
- Buka penutup tab cucian dan penutup dalam/luar tab pemutar seketika (kira-kira 1 jam). Kemudian tutup semula.



## SINGER® Panduan baikpulih - Soaljawab

(Jika mesin disyaki rosak, cabut palam kuasa sebelum periksa) Kadangkala keadaan berikut bukan bermaksud mesin rosak. Pastikan lagi sebelum hantar dibaiki. Jika rosak, datang ke pusat servis atau kedai SINGER yang terdekat. Jangan cuba membaiki dengan sendiri.

Keadaan	Sebab
Mesin tidak berfungsi.	<ul style="list-style-type: none"><li>• Adakah bekalan elektrik terputus?</li><li>• Adakah palam kuasa longgar?</li><li>• Adakah penggetar tersekat bendasing?</li></ul>
Saluran tidak berfungsi.	<ul style="list-style-type: none"><li>• Adakah hos pembuangan air diletak pada lantai?</li><li>• Adakah hos pembuangan air tersekat bendasing?</li><li>• Adakah cucian jatuh ke tepi luar tab pemutar?</li></ul>
Bunyi luar biasa muncul semasa cucian.	<ul style="list-style-type: none"><li>• Adakah pin rambut, syiling atau objek logam dimasukkan ke tab?</li></ul>
Bunyi luar biasa dan getaran kencang muncul semasa berputar.	<ul style="list-style-type: none"><li>• Adakah mesin condong?</li><li>• Adakah pundi ditekan rata?</li><li>• Adakah cucian jatuh ke tepi luar tab pemutar?</li><li>• Adakah cucian dalam tab pemutar terlebih?</li></ul>

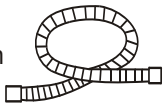

## SINGER® Senarai komponen

Nama	Kuantiti
<ul style="list-style-type: none"> <li>● Panduan pengguna</li> </ul>	<ul style="list-style-type: none"> <li>● 1 keping</li> </ul>
<ul style="list-style-type: none"> <li>● Hos masukan air</li> </ul> 	<ul style="list-style-type: none"> <li>● 1 keping</li> </ul>
<ul style="list-style-type: none"> <li>● Kad jaminan</li> </ul>	<ul style="list-style-type: none"> <li>● 1 keping</li> </ul>
<ul style="list-style-type: none"> <li>● Pundi</li> </ul> 	<ul style="list-style-type: none"> <li>● 1 keping</li> </ul>
<ul style="list-style-type: none"> <li>● Mesin basuh separuh automatik</li> </ul>	<ul style="list-style-type: none"> <li>● 1 set</li> </ul>

### Spesifikasi\*

Paras air / Kuantiti air (jangka) (L)	Maksimum/99 Sederhana/79 Minimum/59
Voltan Bertanda/Frekuensi Bertanda	220V-240V/50Hz
Kuasa bertanda masukan untuk cucian	400
Kuasa bertanda masukan untuk putaran	180
Muatan cucian piawai bertanda (kg)	12.0
Muatan cucian maksimum bertanda (kg)	13.0
Muatan putaran piawai bertanda (kg)	7.0
Tekanan suntikan (MPa)	0.02~0.2

\*Spesifikasi mungkin diubahkan tanpa pemberitahuan awal.

SINGER( MALAYSIA) SDN. BHD . (Company No 97871-K)  
Bangunan SINGER ,Lot 6 ,Jalan 51/217 ,Section 51,  
46050 Petaling Jaya,  
Selangor Darul Ehsan,  
Malaysia.



SINGER PARTS & SERVICE CENTRE  
3rd floor,34&36,Jalan Tago 9,  
Taman Perindustrian Tago BT,11  
Sri.Damansara,52200  
Kuala Lumpur  
Malaysia

---

**SINGER**<sup>®</sup>  
AT HOME WORLDWIDE™